



FM IF System (Quadrature Detector) for Car Radio

Features

1. On-chip IF count buffer circuit and microprocessor-controlled switch circuit for ETR.
2. Compared to the LA1140, the LA1145, 1145M offer:
 - ① Improved signal meter output linearity;
 - ② Improved band mute temperature stability;
 - ③ Improved S/N ratio;
 - ④ Improved sound quality at weak signal input when noise is present, and;
 - ⑤ Improved AMR characteristics during weak signal input.
3. Reduced parts' count simplifies design:
 - ① On-chip IF count buffer circuit;
 - ② On-chip SD circuit — sensitivity can be set independently of soft mute characteristics, and;
 - ③ Variable S-meter gradient — three pin S-meter output (pins 5, 16 and 17) facilitates independent control of SNC and HCC.

Package Dimensions

unit : mm

3115-SIP18Z

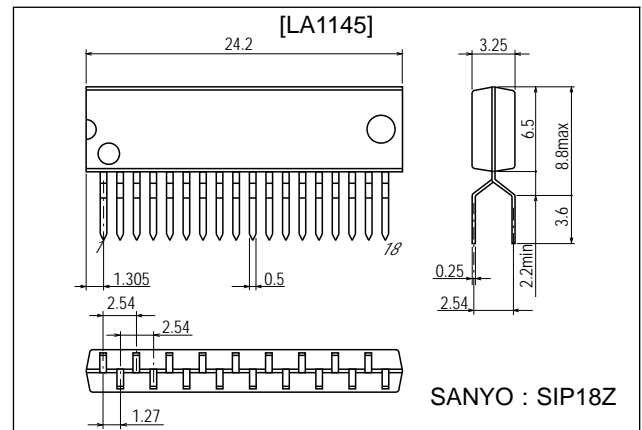

unit : mm

3036C-MFP20

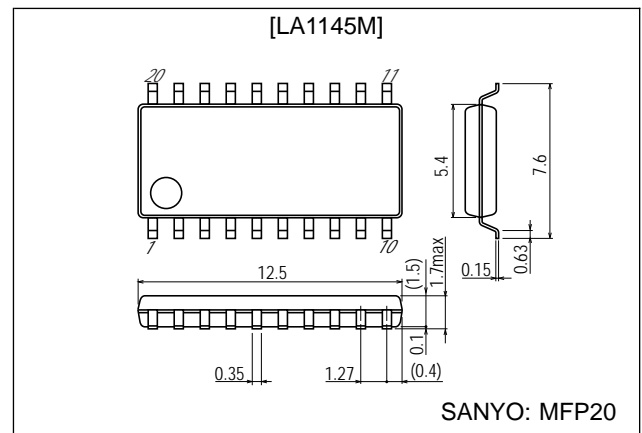

■ Any and all SANYO products described or contained herein do not have specifications that can handle applications that require extremely high levels of reliability, such as life-support systems, aircraft's control systems, or other applications whose failure can be reasonably expected to result in serious physical and/or material damage. Consult with your SANYO representative nearest you before using any SANYO products described or contained herein in such applications.

■ SANYO assumes no responsibility for equipment failures that result from using products at values that exceed, even momentarily, rated values (such as maximum ratings, operating condition ranges, or other parameters) listed in products specifications of any and all SANYO products described or contained herein.

LA1145, 1145M

Specifications

[LA1145]

Maximum Ratings at Ta = 25 °C

Parameter	Symbol	Conditions	Ratings	Unit
Maximum supply voltage	V _{CC} max	Pin 12	14	V
Maximum supply current	I _{CC} max	Pin 12	45	mA
Allowable power dissipation	Pd max	Ta = 65 °C	630	mW
		Ta = 70°C	590	mW
Operating temperature	Topr		-20 to +70	°C
Storage temperature	Tstg		-40 to +150	°C

Operating Conditions at Ta = 25 °C

Parameter	Symbol	Conditions	Ratings	Unit
Recommended supply voltage	V _{CC}		8	V
Operating voltage range	V _{CC} op		7.5 to 14	V

Operating Characteristics at Ta = 25°C, V_{CC} = 8 V, f_{in} = 10.7 MHz

Parameter	Symbol	Conditions	min	typ	max	Unit
Quiescent current	I _{CCO}	V _{IN} = 0 dBμ	18	26	36	mA
Current drain	I _{CC}	V _{IN} = 100 dBμ	20	29	36	mA
Demodulation output	V _O	V _{IN} = 100 dBμ, 400 Hz tone, 100%	300	400	520	mVrms
Total harmonic distortion	THD	V _{IN} = 100 dBμ, 400 Hz tone, 100%, single tuning coil		0.3	0.8	%
Signal-to-noise ratio	S/N	V _{IN} = 100 dBμ, 400 Hz tone, 100%	79	85		dB
Input limiting voltage	V _{IN} (lim)	400 Hz tone, 100%, soft mute ON	34	40	46	dBμ
Muting sensitivity	V _{IN} (mute)	V ₁₅ = 2 V	30	36	42	dBμ
Muting bandwidth	BW(mute)	V _{IN} = 100 dBμ, V ₁₈ ≤ 0.3 V	140	190	280	kHz
Muting attenuation	mute(1)	V _{IN} = 100 dBμ, V ₁₅ = 2 V, 400 Hz tone, 100%	10	15	20	dB
	mute(2)	V _{IN} = 100 dBμ, V ₁₅ = 4 V, 400Hz tone, 100%	25	29	33	dB
Signal strength indication output	V ₁₆₋₀	V _{IN} = 0 dBμ, R _A = 10 kΩ, pin 16	0	0.1	0.4	V
	V ₁₆₋₅₀	V _{IN} = 50 dBμ, R _A = 10 kΩ, pin 16	1.4	2.3	3.2	V
	V ₁₆₋₇₀	V _{IN} = 70 dBμ, R _A = 10 kΩ, pin 16	2.5	4.5	5.5	V
	V ₁₆₋₁₀₀	V _{IN} = 100 dBμ, R _A = 10 kΩ, pin 16	5.0	5.5	6.0	V
Muting drive output	V ₁₅₋₀	V _{IN} = 0 dBμ, pin 15	4.0	4.8	5.5	V
	V ₁₅₋₁₀₀	V _{IN} = 100 dBμ, pin 15	0	0	0.3	dB
AM rejection ratio	AMR	V _{IN} = 100 dBμ, 1 kHz tone, 30% AM	57	70		dB
Offset voltage	V ₇₋₁₁	V _{IN} = 0 dBμ, pins 7 to 11	-0.25	0	+0.25	V
	V ₈₋₁₁	V _{IN} = 0 dBμ, pin 8 to 11	-0.5	0	+0.5	V
SD sensitivity	V _{SD}	Pin 18	50	58	66	dBμ
IF count output level	V _{IN} (IF)	V _{IN} = 100 dBμ, pin 13, C _L = 10 pF	110	180	280	mVrms

[LA1145M]

Maximum Ratings at Ta = 25 °C

Parameter	Symbol	Conditions	Ratings	Unit
Maximum supply voltage	V _{CC} max	Pin 13	14	V
Maximum supply current	I _{CC} max	Pin 13	45	mA
Allowable power dissipation	Pd max	Ta = 70°C, mounted on PC board, independent IC	630	mW
		Ta = 25°C, mounted on PC board, Independent IC	630	mW
Operating temperature	Topr		-20 to +70	°C
Storage temperature	Tstg		-40 to +125	°C

LA1145, 1145M

Operating Conditions at Ta = 25°C

Parameter	Symbol	Conditions	Ratings	Unit
Recommended supply voltage	V _{CC}		8	V
Operating voltage range	V _{CC op}		7.5 to 14	V

Operating Characteristics at Ta = 25 °C, V_{CC} = 8 V, f_{in} = 10.7 MHz

Parameter	Symbol	Conditions	min	typ	max	Unit
Quiescent current	I _{CCO}	V _{IN} = 0 dBμ	18	26	36	mA
Current drain	I _{CC}	V _{IN} = 100 dBμ	20	29	40	mA
Demodulation output	V _O	V _{IN} = 100 dBμ, 400 Hz tone, 100%	300	400	520	mVrms
Total harmonic distortion	THD	V _{IN} = 100 dBμ, 400 Hz tone, 100%, single tuning coil		0.3	0.8	%
Signal-to-noise ratio	S/N	V _{IN} = 100 dBμ, 400 Hz tone, 100%	79	85		dB
Input limiting voltage	V _{IN (lim)}	400 Hz tone, 100%, soft mute ON	34	40	46	dBμ
Muting sensitivity	V _{IN (mute)}	V ₁₆ = 2 V	30	36	42	dBμ
Muting bandwidth	BW (mute)	V _{IN} = 100 dBμ, V ₁₉ ≤ 0.3 V	140	190	280	kHz
Muting attenuation	mute (1)	V _{IN} = 100 dBμ, V ₁₆ = 2 V, 400 Hz tone, 100%	10	15	20	dB
	mute (2)	V _{IN} = 100 dBμ, V ₁₆ = 4 V, 400 Hz tone, 100%	25	29	33	dB
Signal strength indication output	V ₁₇₋₀	V _{IN} = 0 dBμ, R ₁₆ = 10 kΩ, pin 17	0	0.1	0.4	V
	V ₁₇₋₅₀	V _{IN} = 50 dBμ, R ₁₆ = 10 kΩ, pin 17	1.4	2.3	3.2	V
	V ₁₇₋₇₀	V _{IN} = 70 dBμ, R ₁₆ = 10 kΩ, pin 17	2.5	4.5	5.5	V
	V ₁₇₋₁₀₀	V _{IN} = 100 dBμ, R ₁₆ = 10 kΩ, pin 17	5.0	5.5	6.0	V
Muting drive output	V ₁₆₋₀	V _{IN} = 0 dBμ, pin 16	4.0	4.8	5.5	V
	V ₁₆₋₁₀₀	V _{IN} = 100 dBμ, pin 16	0	0	0.3	V
AM rejection ratio	AMR	V _{IN} = 100 dBμ, 1 kHz tone, 30% AM	57	70		dB
Offset voltage	V ₈₋₁₂	V _{IN} = 0 dBμ, pin 8 to 12	-0.25	0	+0.25	V
	V ₉₋₁₂	V _{IN} = 0 dBμ, pin 9 to 12	-0.5	0	+0.5	V
SD sensitivity	V _{SD}	Pin 19	50	58	66	dBμ
IF count output level	V _{IF-On}	V _{IN} = 100 dBμ, pin 14, C _L = 10 pF	110	180	280	mVrms
	V _{IF-OFF}	V _{IN} = 100 dBμ, pin 14, C _L = 10 pF		1	3	mVrms

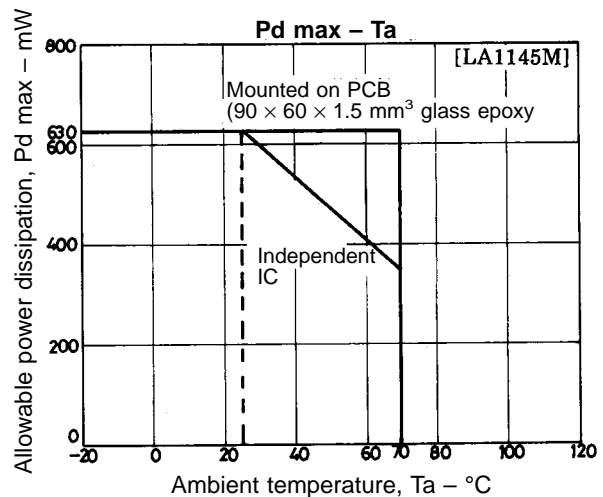
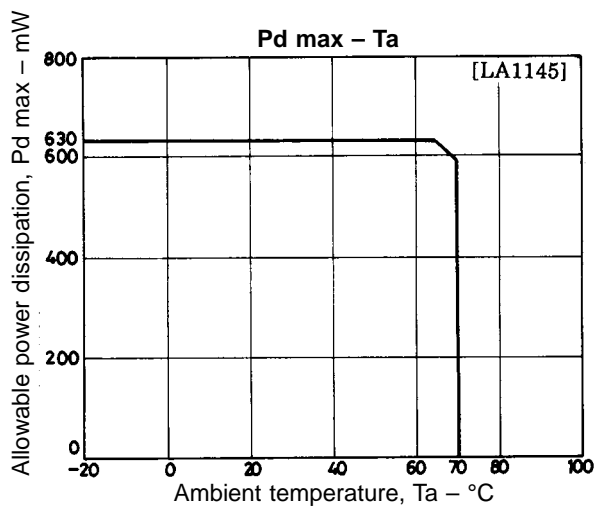

LA1145, 1145M

LA1145 Equivalent Circuit Block Diagram

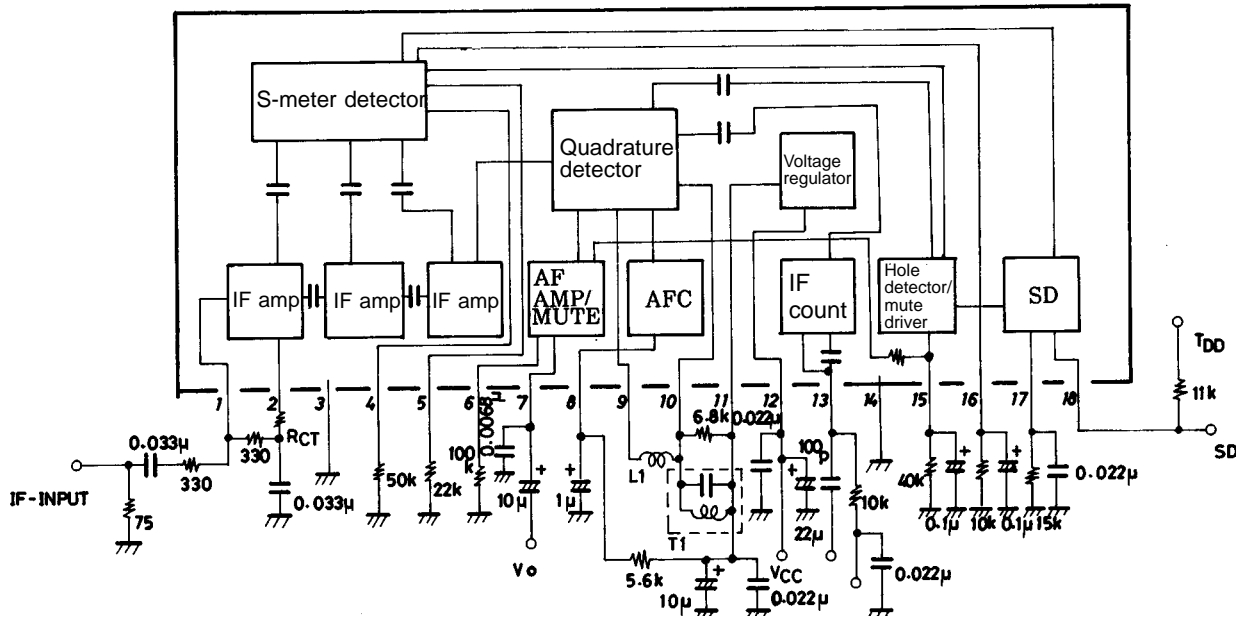

Unit (resistance: Ω, capacitance: F)

LA1145M Equivalent Circuit Block Diagram

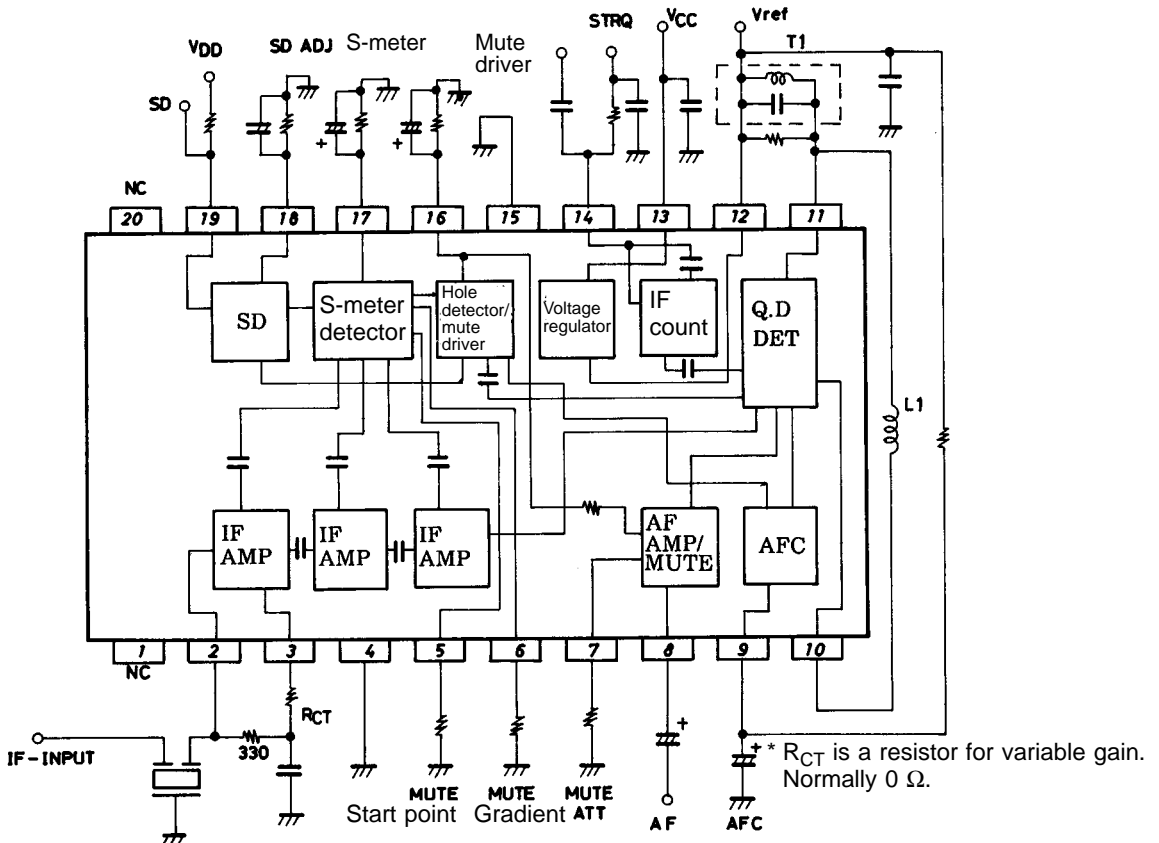

LA1145, 1145M

Sample Application Circuit

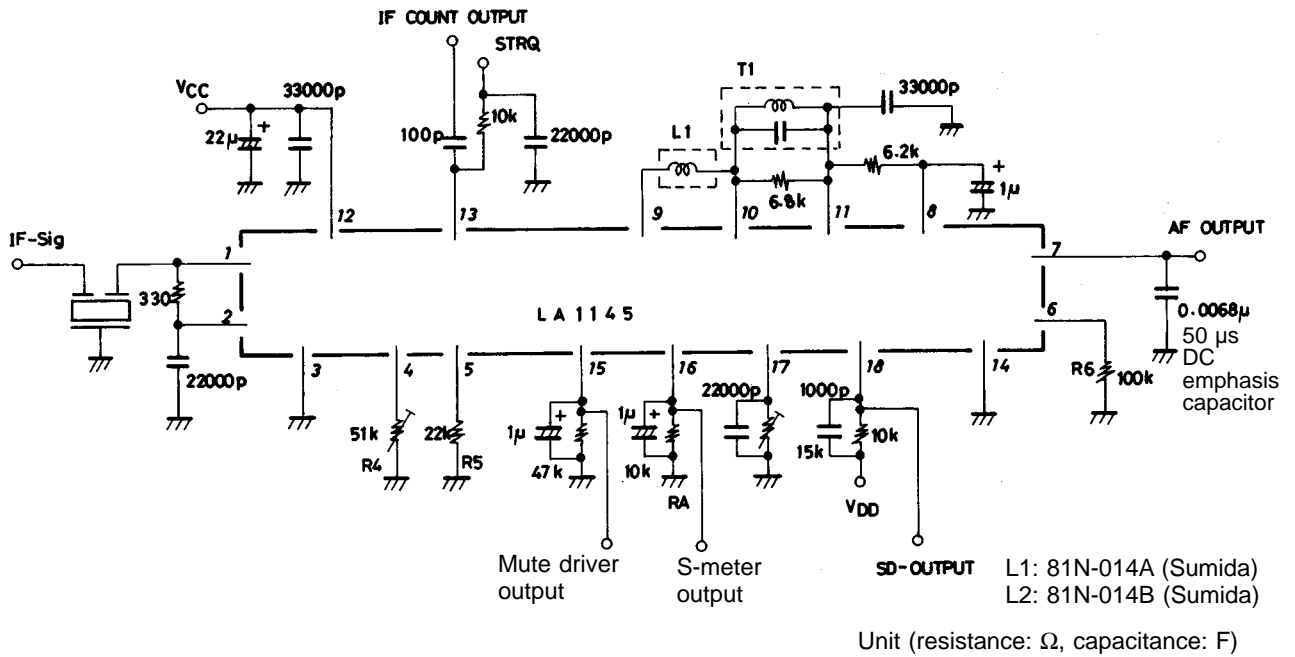

LS1140 and LS1145 Compared

Parameter	LA1140	LA1145	Remarks
Package	SIP-16	SIP-18Z MFP-20	
IF amp, limiter	Direct-coupled	C-coupled	
Quadrature detector	○	○	
AF preamp	○	○	
AFC output	○	○	
Signal meter output	○	⊙	Improved linearity, variable S-meter gradient
Band muting	○	⊙	Improved temperature stability, V_{BE} dependent
IF count buffer output	–	○	Common with STRQ
SD circuit	–	○	For the LA1140, Coupled with the soft muting function.
S/N	78 dBμ	86 dB	
3 dBμ limiting sensitivity	25 dBμ (fixed)	25 to 40 dBμ	–3 dBμ limiting sensitivity variable, independent of soft muting function
Weak signal noise output	○	⊙	

LA1145, 1145M

LA1145 Pin Description and Typical Voltages





Pin No.	Typical Voltage (V)	Description	Remarks
1	2.6	IF input	
2	2.6	IF amp bias	
3	0.0	IF amp GND	
4	4.0	Mute start control	
5	0.2	Mute gradient control	
6	2.1	Mute attenuation control	
7	4.9	AF output	
8	5.0	AFC output	
9	4.8	IF output	
10	4.8	Quadrature detection input	
11	4.8	Voltage regulator output	
12	8.0	V _{CC}	
13	0.1	IF count output, control	
14	0.0	GND for detection circuit	
15	4.8	Mute driver	
16	0.2	S-meter output	
17	0.2	SD sensitivity control	
18	0.1	SD output	Open collector

LA1145M Pin Description and Typical Voltages

Pin No.	Typical Voltage (V)	Description	Remarks
1	–	NC	
2	2.6	IF input	
3	2.6	IF amp bias	
4	0.0	IF amp GND	
5	4.0	Mute start control	
6	0.2	Mute gradient control	
7	2.1	Mute attenuation control	
8	4.9	AF output	
9	5.0	AFC output	
10	4.8	IF output	
11	4.8	Quadrature detection input	
12	4.8	Voltage regulator output	
13	8.0	V _{CC}	
14	0.1	IF count output, control	
15	0.0	GND for detection circuit	
16	4.8	Mute driver	
17	0.2	S-meter output	
18	0.2	SD sensitivity control	
19	0.1	SD output	Open collector
20	–	NC	

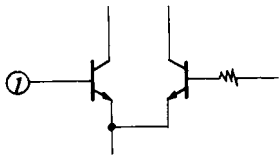
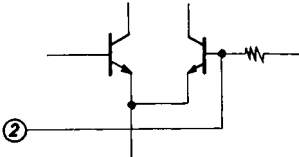

LA1145, 1145M

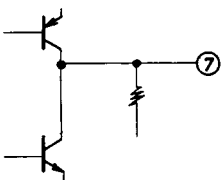
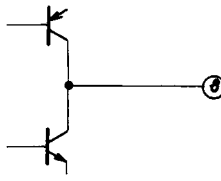
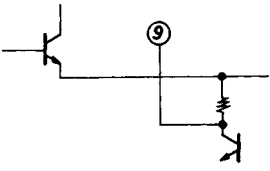
LA1145 Pin Functions (1)

Pin No.	Function	Internal Equivalent Circuit	Notes
1	IF input		
2	Bias pin		
3	GND		IF limiting amp GND
4	Soft mute start point control		For setting the soft mute starting point.
5	Soft muting gradient control pin		Can be used for S-meter output. For setting the mute gradient from the soft mute starting point to the noise finishing point.
6	Mute Att		For setting amount of mute attenuation. The demodulation level changes when the external resistance value is varied.
7	FM-AF output		
8	AFC input		
9	IF output		Output to the phase circuit

LA1145, 1145M

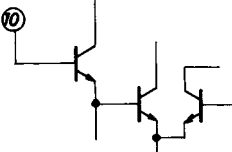
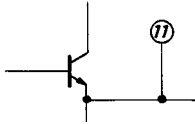
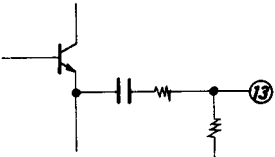
LA1145 Pin Functions (2)

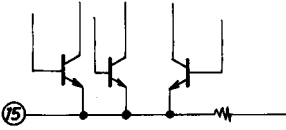
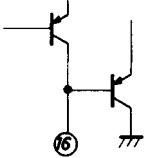
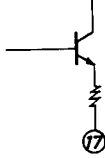
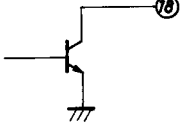
Pin No.	Function	Internal Equivalent Circuit	Notes
10	IF input		IF input via the phase shift circuit. The mute circuit malfunctions and demodulation output decreases if the voltage level at this pin drops below 180 mV.
11	Vref		4.8 V
12	V _{CC}		Supply voltage 7.5 to 14 V
13	IF buffer output		
14	GND		FM detection circuit GND
15	Mute driver		Amount of mute attenuation depends on and is controlled by the voltage at this pin.
16	S-meter output		PNP open collector output
17	SD sensitivity setting		Can be used for S-meter output
18	SD output		High active

SD Output Circuit

1. LA1145 SD output differs from the LA1140's pin substitute SD output as shown below. The SD output on the LA1145 does not operate in conjunction with the soft mute characteristics.

1) LA1140

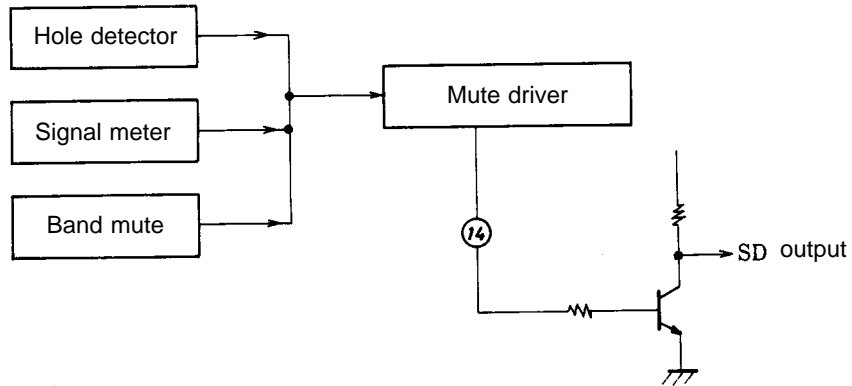

2) LA1145

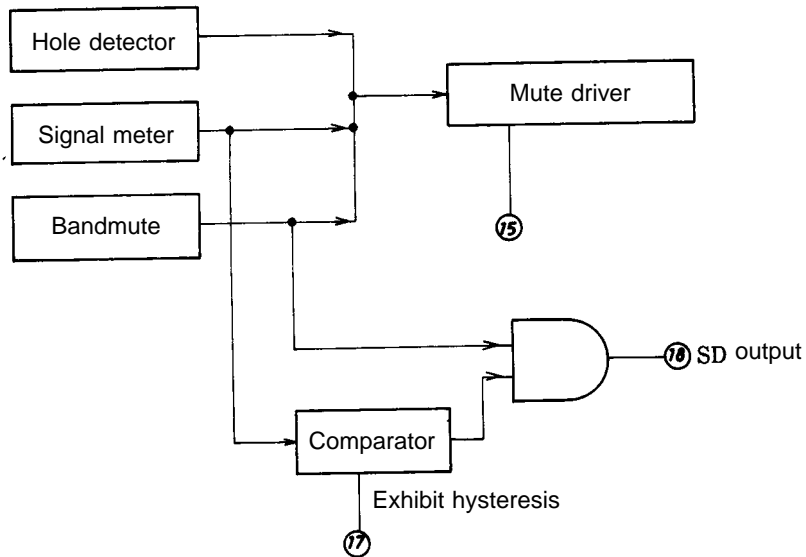

As shown, the SD output is the logical AND of the band mute and S-meter comparator outputs.

2. Signal search using the SD output circuit

2-1 The transition response characteristics of the SD output circuit depends on the time constants of pins 15, 16, 17 and 8. As the SD output transition response characteristics are determined by the pin with the largest time constant, erroneous stopping will result when a search time is less than the largest one.

2-2 Band mute range circuit time constant (pin 8)

An equivalent circuit to the band circuit is shown below.

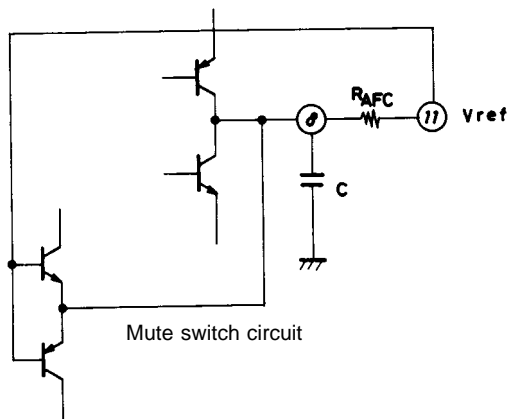

1) Current path during detuning

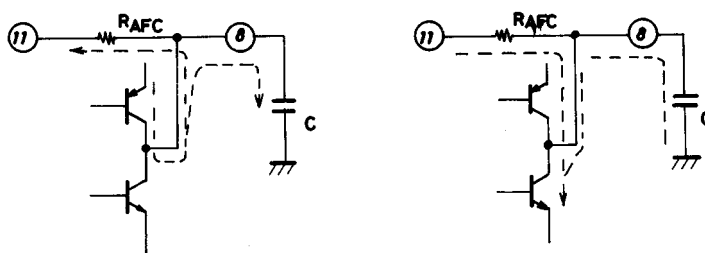

2) Current return path from detuning

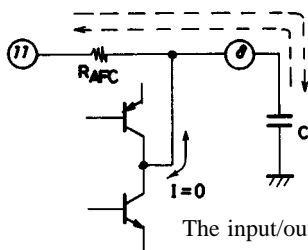

The input/output current from pin 8 becomes zero during return.

As can be seen from the above circuit diagrams, the time constant during detuning is determined by the internal PNP resistance, the NPN collector resistance and the capacitance of the externally- mounted capacitor. This time constant is determined by the external resistance R_{AFC} and capacitor C . This time constant, $\tau = R_{AFC} \times C$, must be set depending on the required search time.

3. Narrow-band SD output circuit

An IF count circuit is provided for equipment compatibility for the European marketplace. However, if the band is made narrow using only the SD circuit, there is a tendency for the number of erroneous stops caused by an undesired signal to increase. To prevent this, two threshold voltages should be used to control the SD circuit.

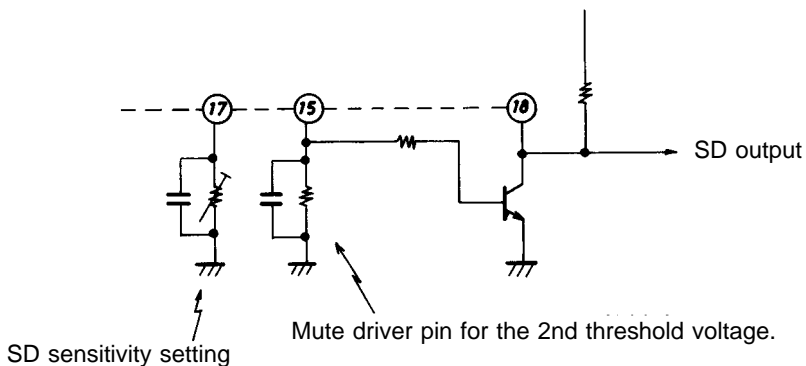

Band Mute Characteristics (1)

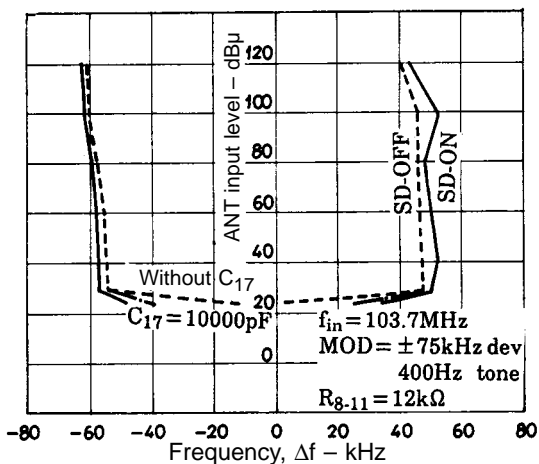

Band Mute Characteristics (2)

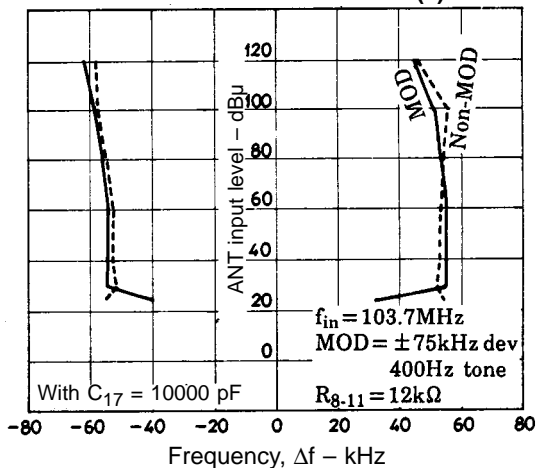

Soft Mute Characteristics

1. Control

The S/N setting (C/N) for weak inputs and the -3 dB limiting sensitivity can be controlled by obtaining the proper value for the un-soft muted input/output signal characteristic. However, usable sensitivity cannot be controlled as this is determined by the front end and IF design which are unrelated to soft muting.

2. Soft mute setting

Soft mute operation depends on the S-meter circuit voltage and the hole detector circuit voltage. As shown in the graph on the right, the degree of soft muting correlates with the mute drive voltage, V15. The control signal line of the mute drive voltage switches before and after the 10 dBμ ANT divergence point.

When adjusting the soft mute with a weak signal which does not affect the S-meter, first adjust it using the hole detector input signal. However, as the S-meter output will readjust the soft mute level, also adjust the soft mute using the S-meter output. At this point, the hole detector output adjusts the gain up to the IF input, causing a variance. Also, the S-meter output is varied by the value of R16.

The LA1145 differs from the LA1140 in that it works with the internal soft mute circuit continuously engaged.

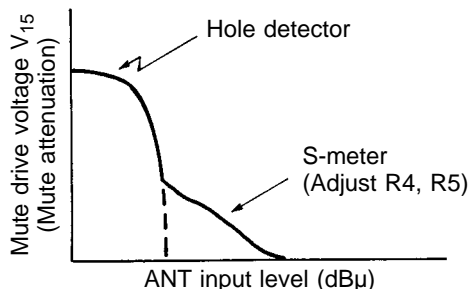

3. Soft mute transition response characteristic

The degree of soft muting automatically varies according to the change in input field strength. Omitting the influence of the front end wideband AGC circuit, the LA1145's response speed is dependent on the time constant at pins 15 and 16.

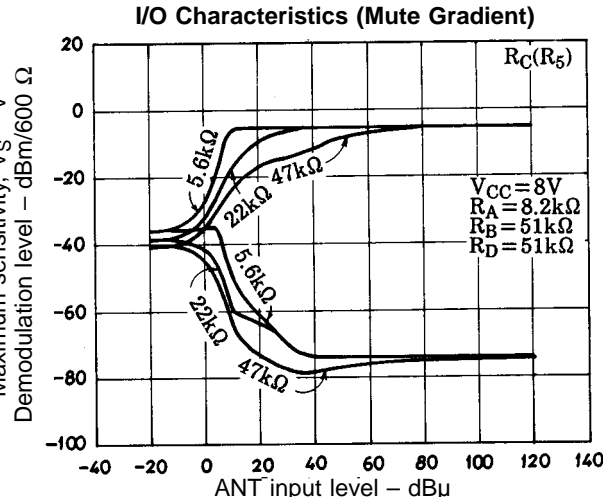
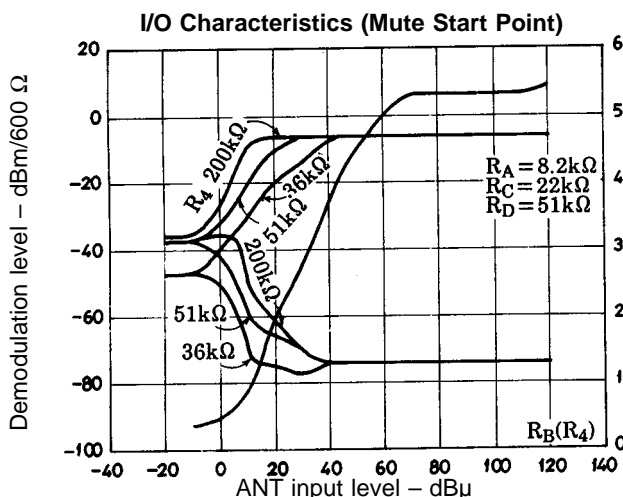
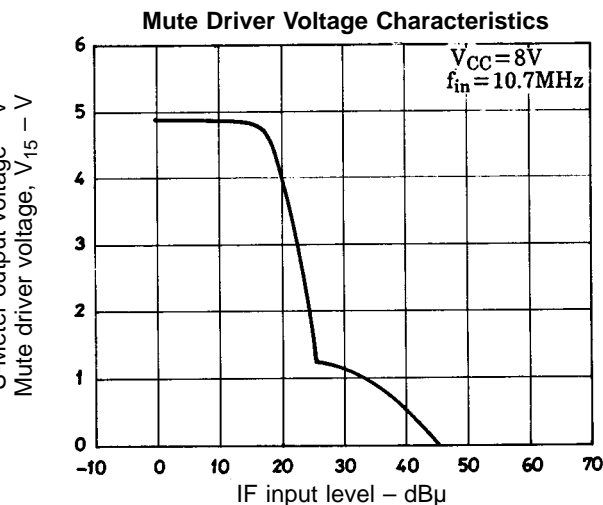
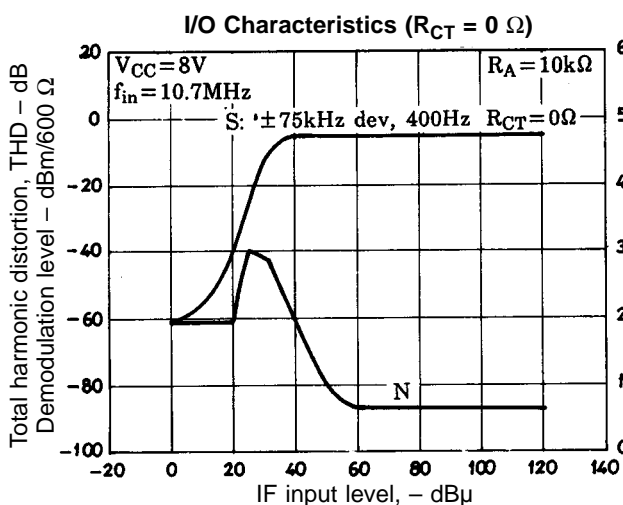

LA1145, 1145M

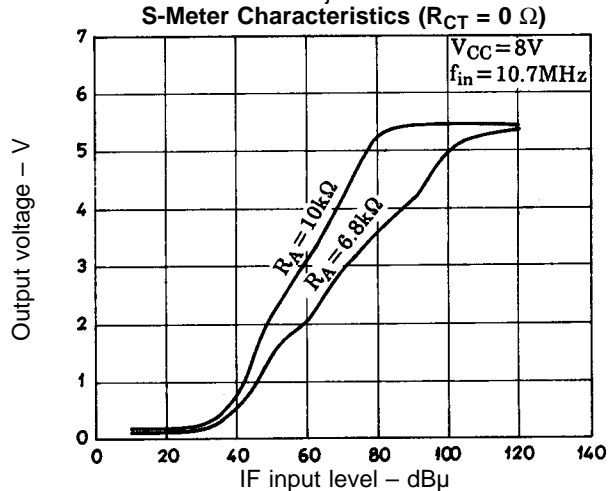
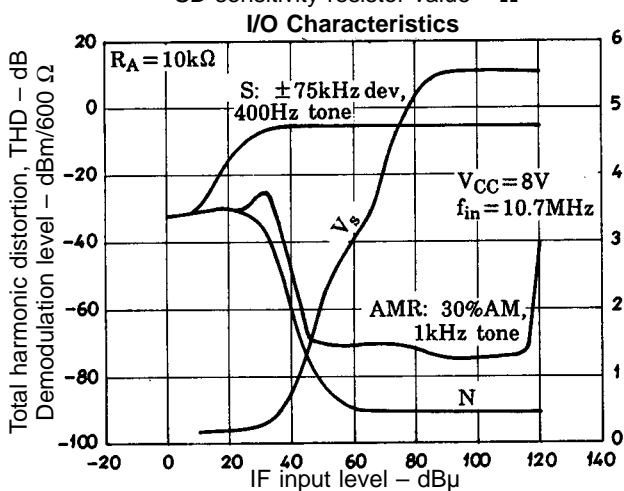
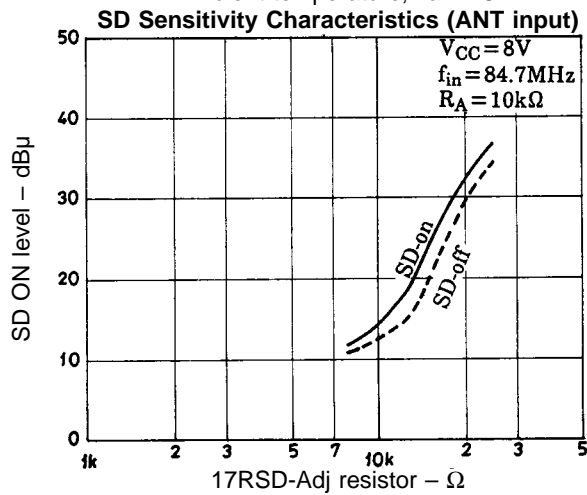
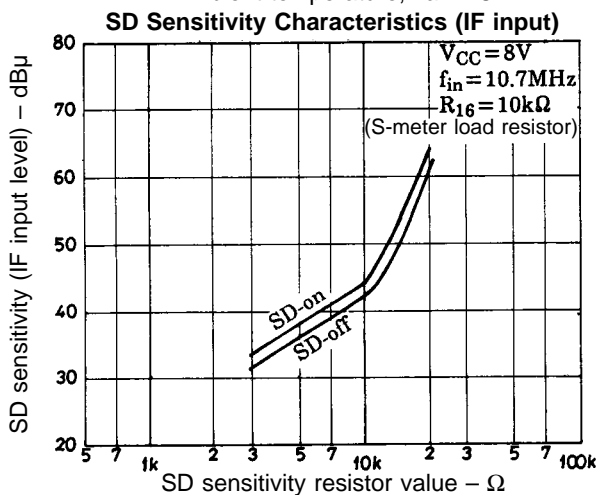
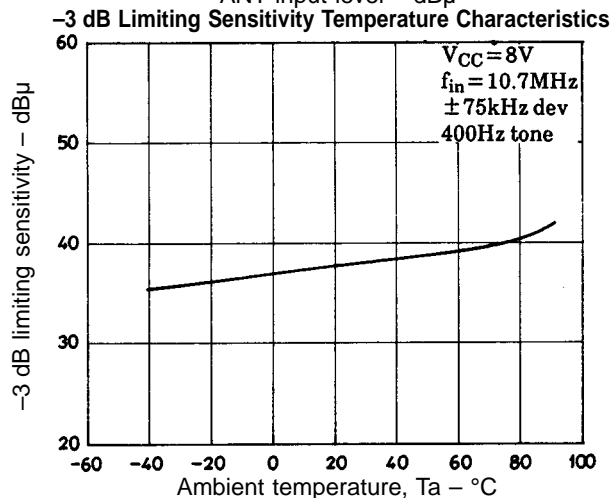
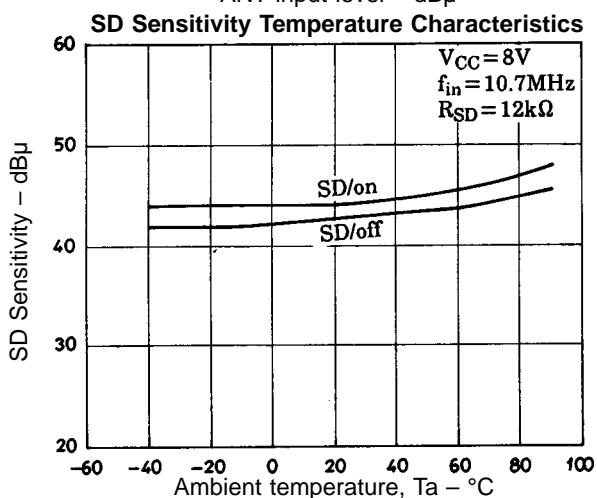
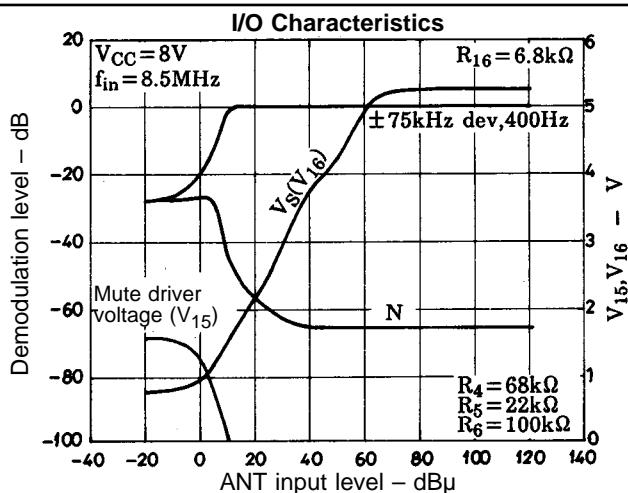
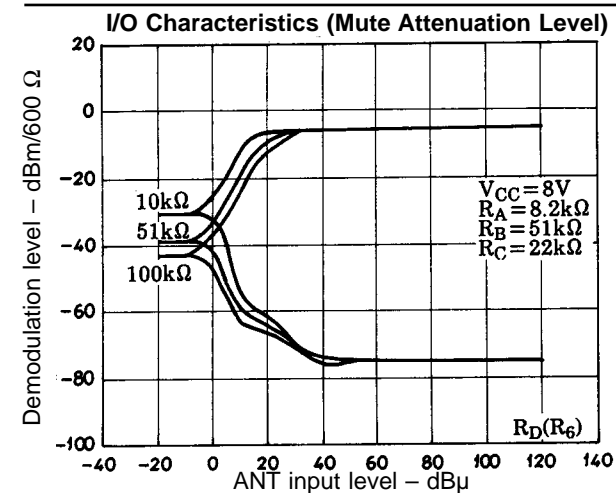

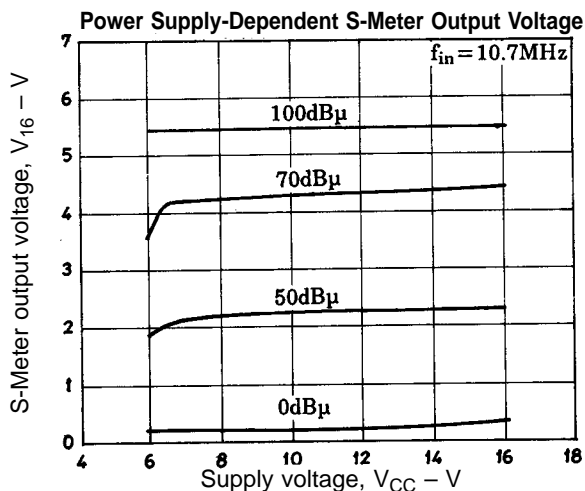
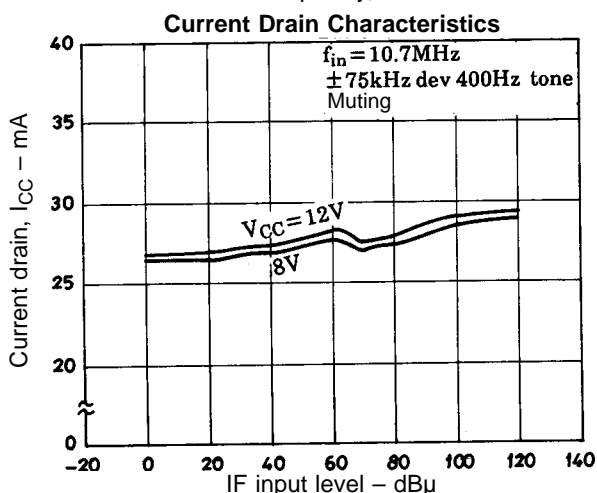
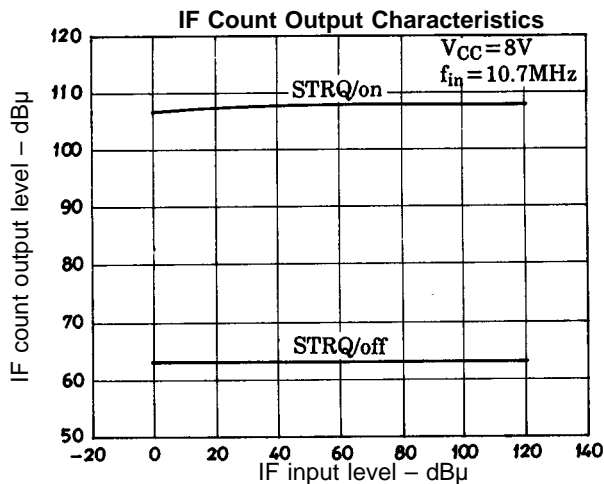
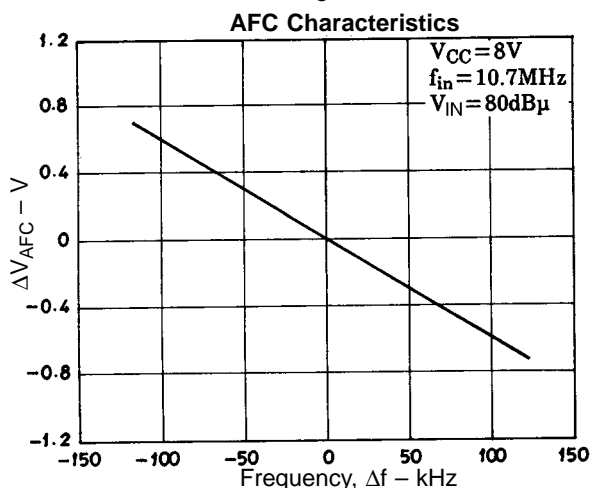
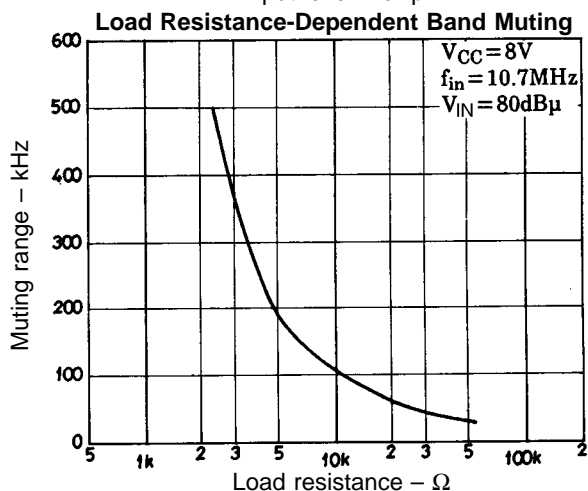
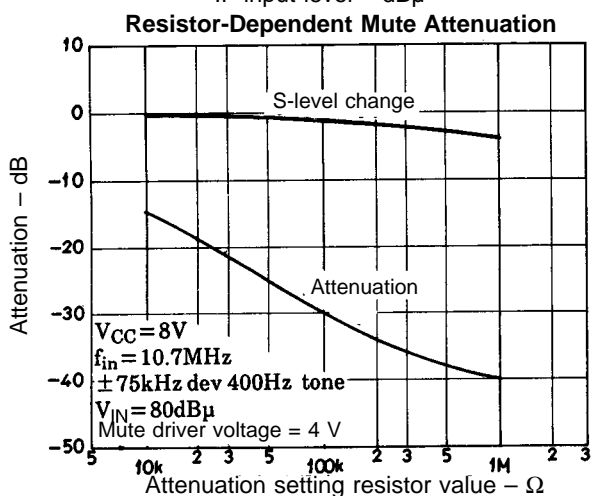
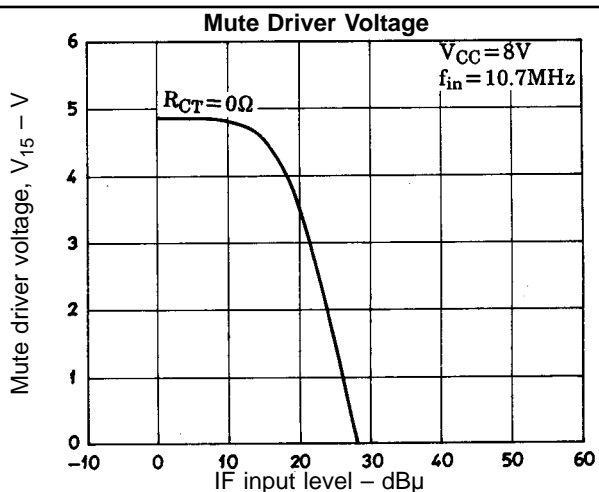
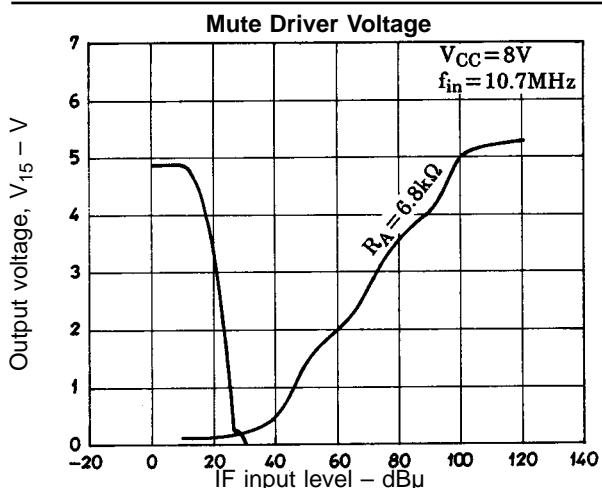

LA1145, 1145M

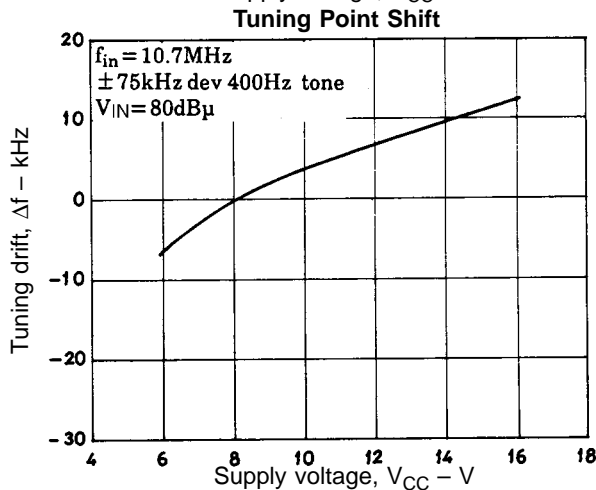
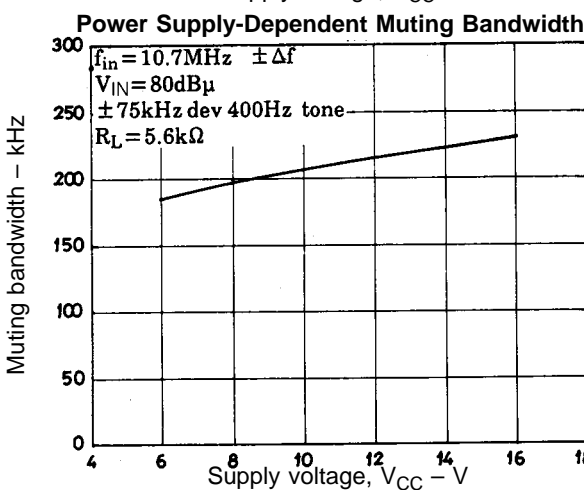
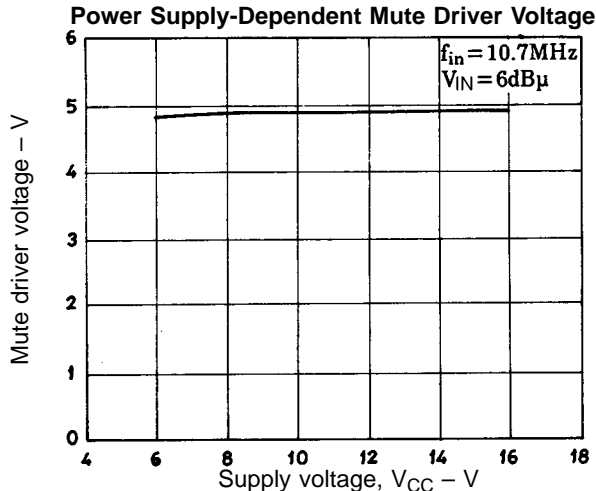
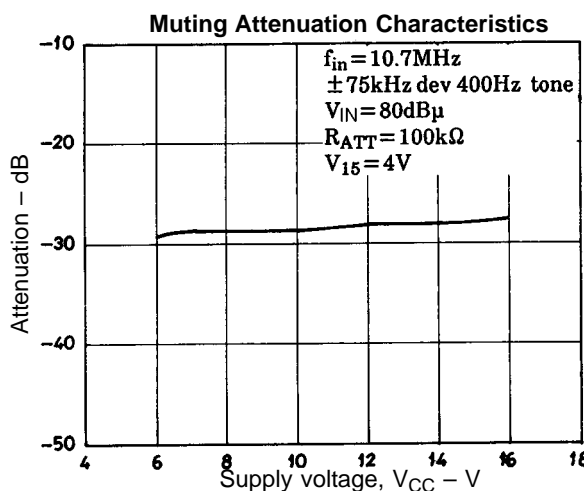
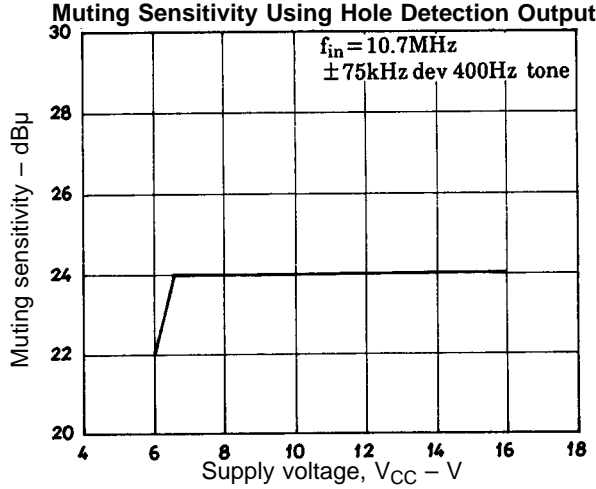
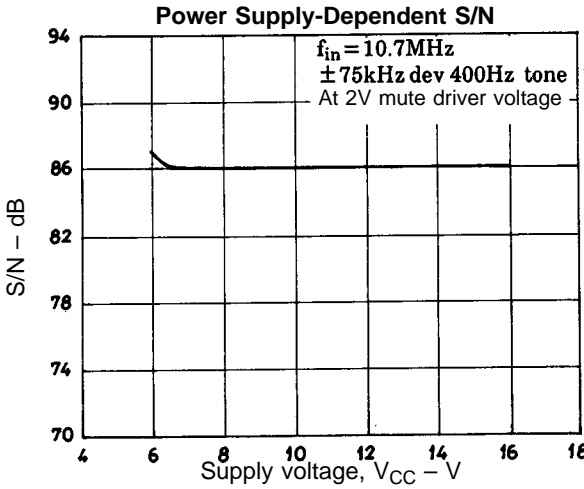
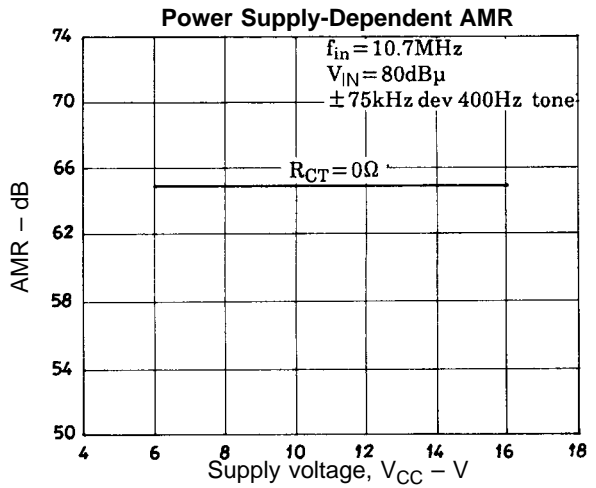
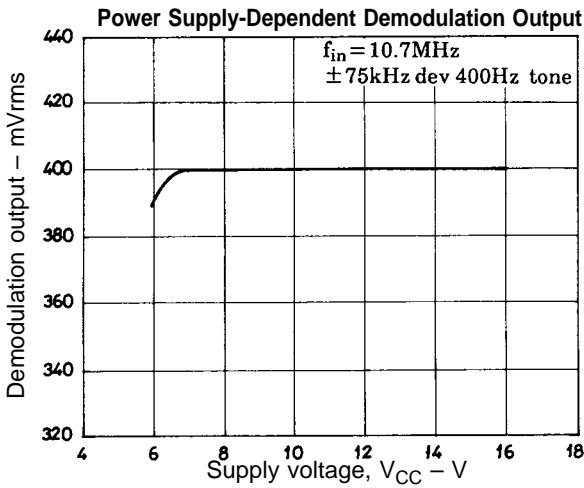

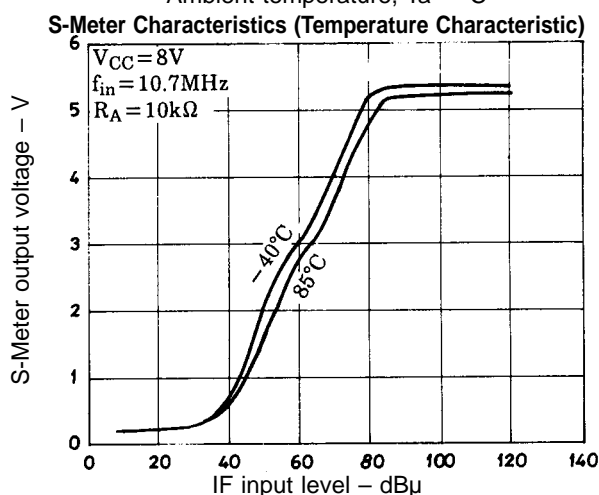
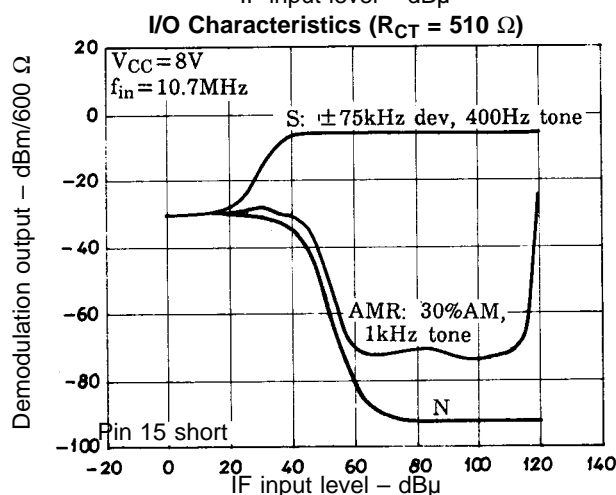
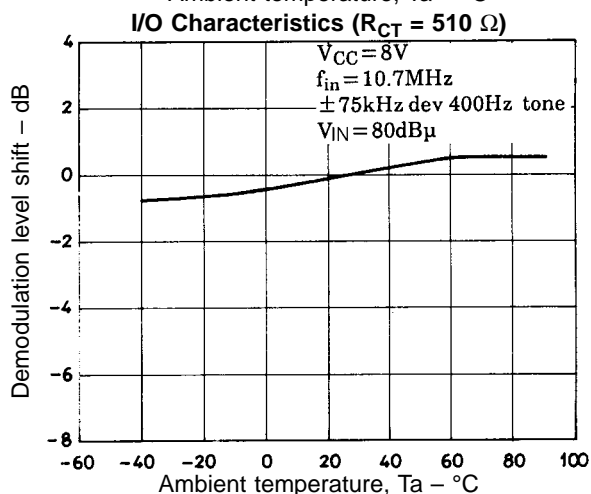
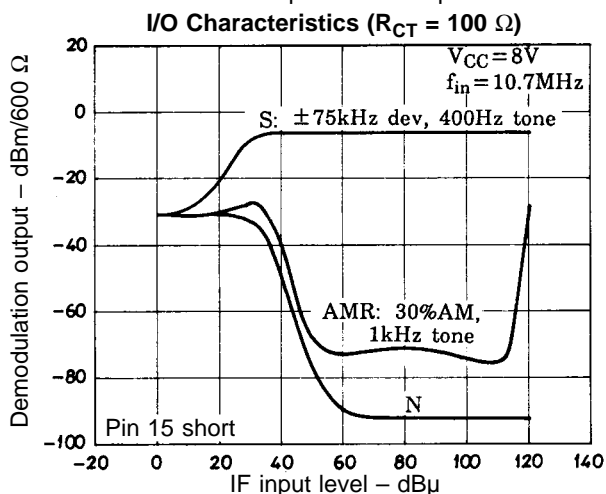
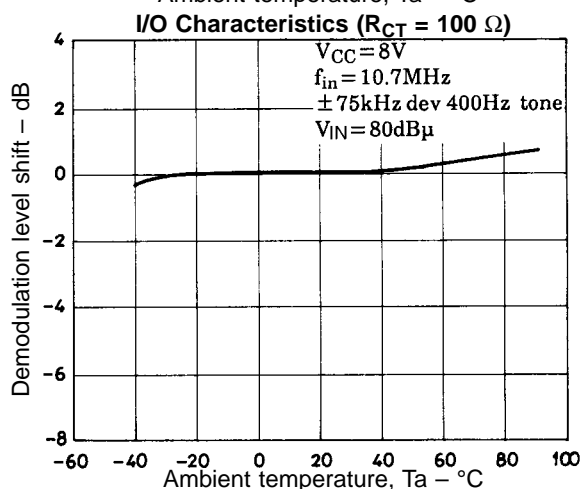
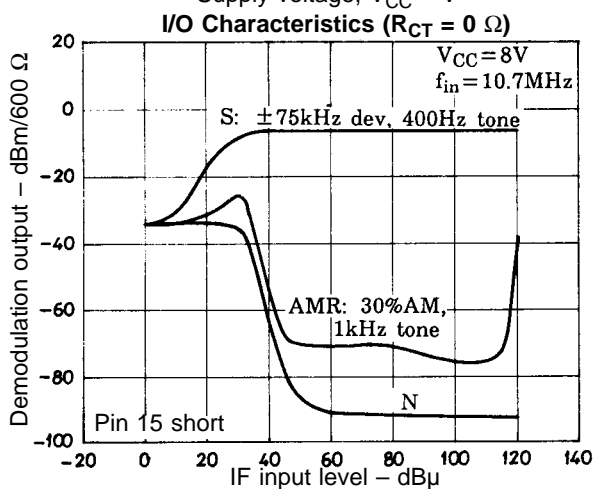
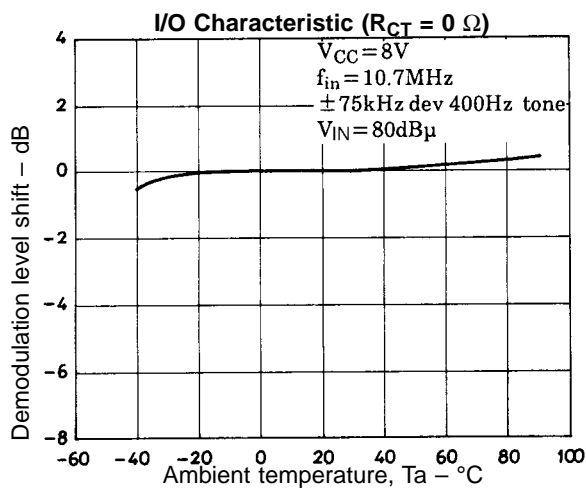
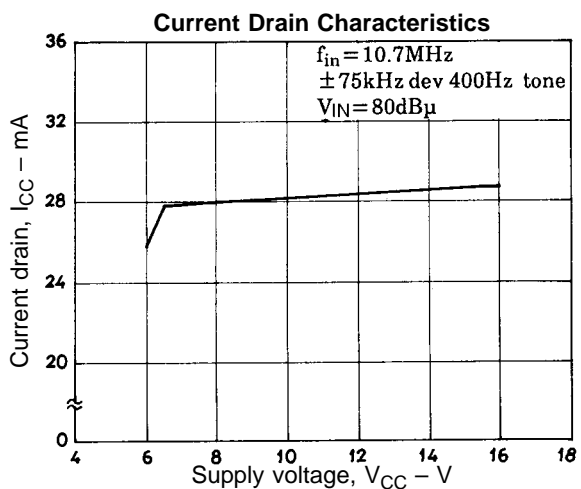

-3 dB Limiting Sensitivity Temperature Characteristics

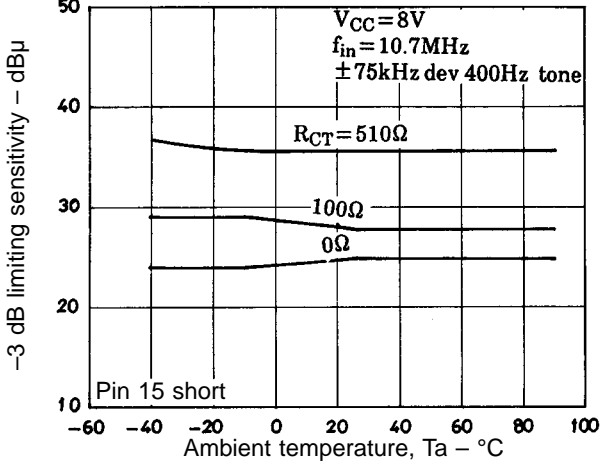

Muting Attenuation Characteristics

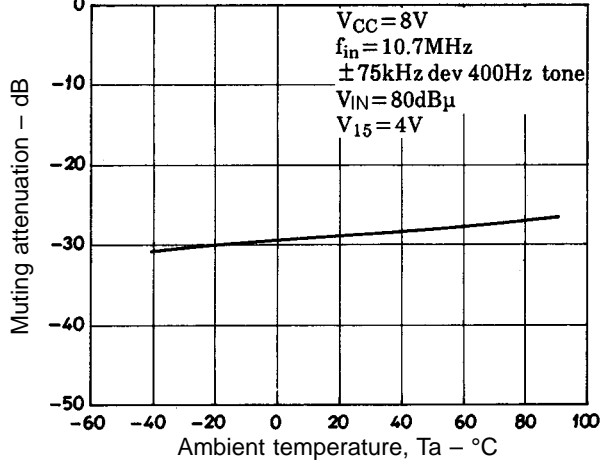

Muting Bandwidth Temperature Characteristics

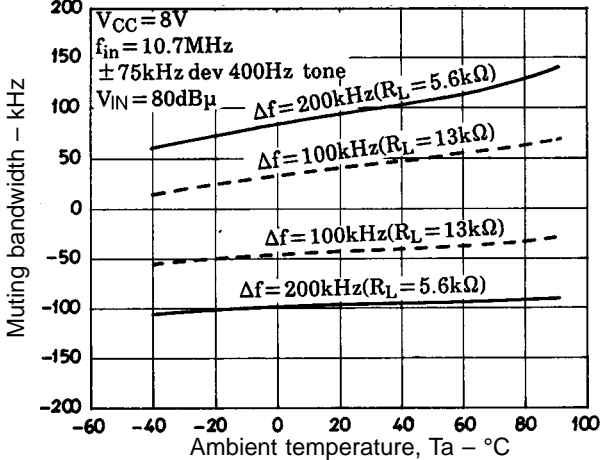

AMR Temperature Characteristics

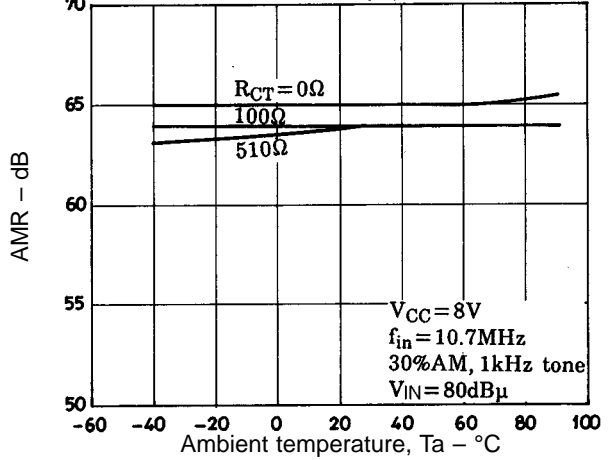

IF Count Output Level Shift

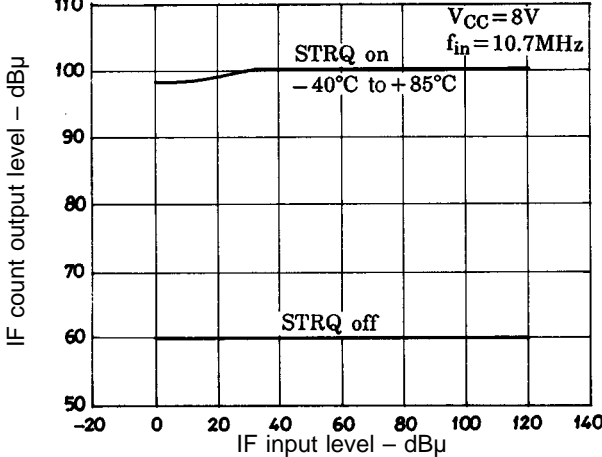

THD Characteristic (Single Tuning Circuit)

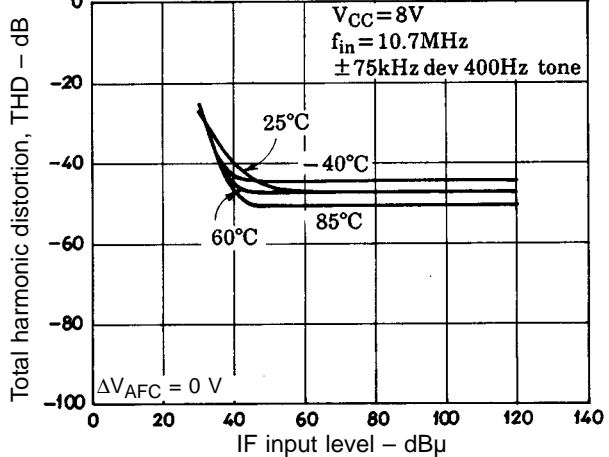

THD Detuning Characteristics

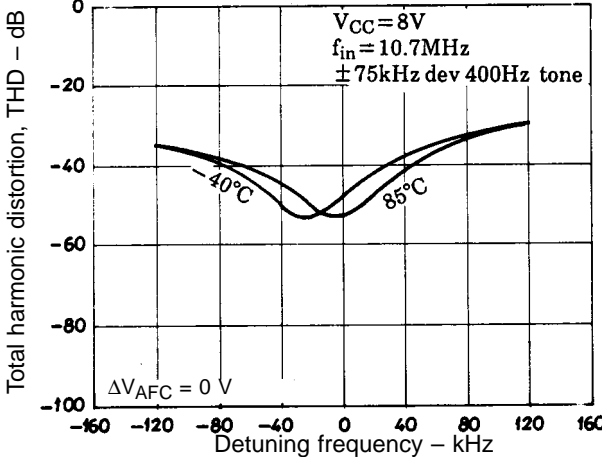

- Specifications of any and all SANYO products described or contained herein stipulate the performance, characteristics, and functions of the described products in the independent state, and are not guarantees of the performance, characteristics, and functions of the described products as mounted in the customer's products or equipment. To verify symptoms and states that cannot be evaluated in an independent device, the customer should always evaluate and test devices mounted in the customer's products or equipment.
- SANYO Electric Co., Ltd. strives to supply high-quality high-reliability products. However, any and all semiconductor products fail with some probability. It is possible that these probabilistic failures could give rise to accidents or events that could endanger human lives, that could give rise to smoke or fire, or that could cause damage to other property. When designing equipment, adopt safety measures so that these kinds of accidents or events cannot occur. Such measures include but are not limited to protective circuits and error prevention circuits for safe design, redundant design, and structural design.
- In the event that any or all SANYO products (including technical data, services) described or contained herein are controlled under any of applicable local export control laws and regulations, such products must not be exported without obtaining the export license from the authorities concerned in accordance with the above law.
- No part of this publication may be reproduced or transmitted in any form or by any means, electronic or mechanical, including photocopying and recording, or any information storage or retrieval system, or otherwise, without the prior written permission of SANYO Electric Co., Ltd.
- Any and all information described or contained herein are subject to change without notice due to product/technology improvement, etc. When designing equipment, refer to the "Delivery Specification" for the SANYO product that you intend to use.
- Information (including circuit diagrams and circuit parameters) herein is for example only; it is not guaranteed for volume production. SANYO believes information herein is accurate and reliable, but no guarantees are made or implied regarding its use or any infringements of intellectual property rights or other rights of third parties.